

LEGO® Education WeDo 2.0

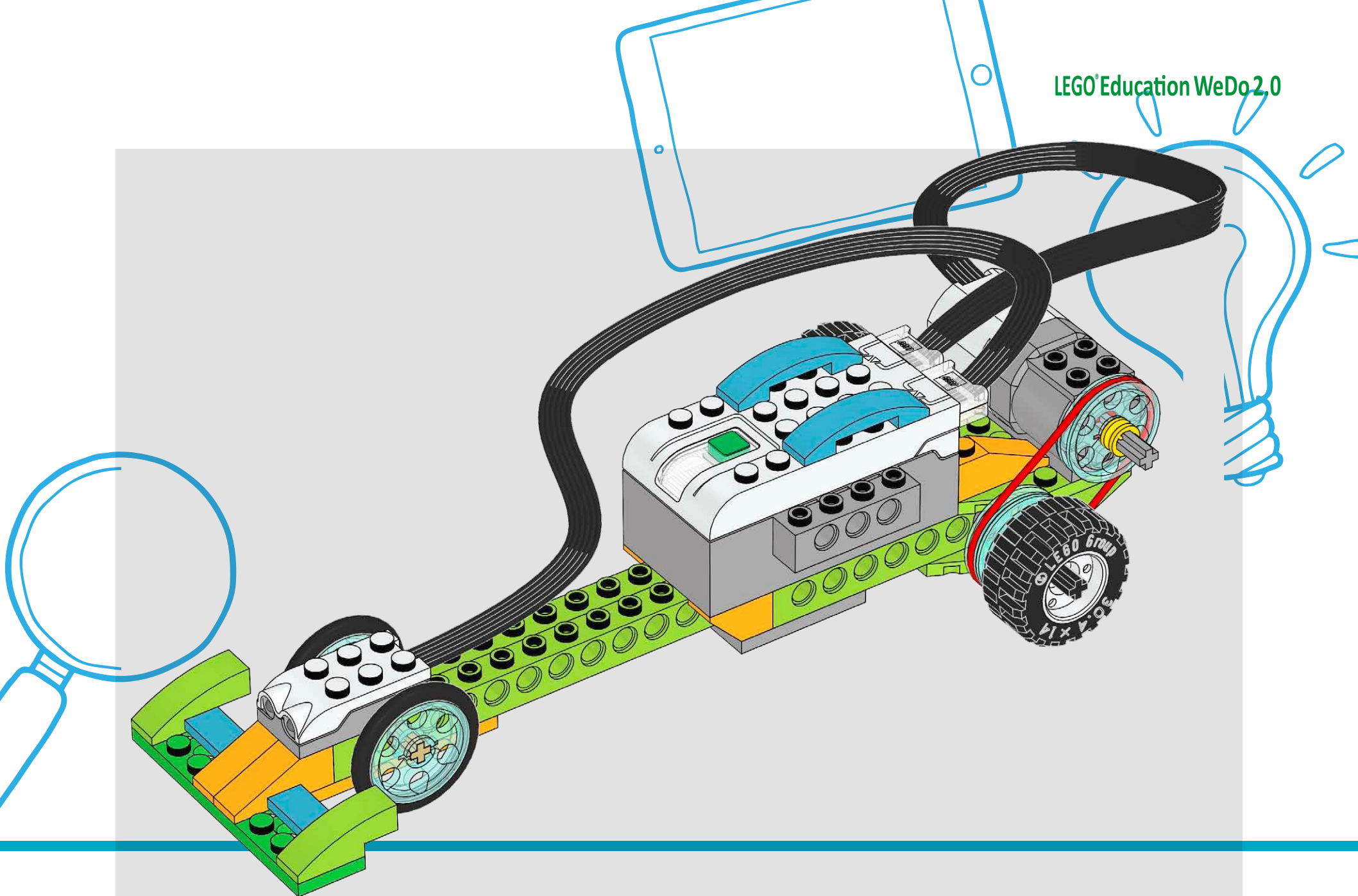

45300

LEGO and the LEGO logo are trademarks of the/son des marques de commerce du/son marcas registradas de LEGO Group. ©2015 The LEGO Group. 088360.



education

LEGO® Education
WeDo 2.0



45300

LEGO and the LEGO logo are trademarks of the/son des marques de commerce
du/son marcas registradas de LEGO Group. ©2015 The LEGO Group. 088360.



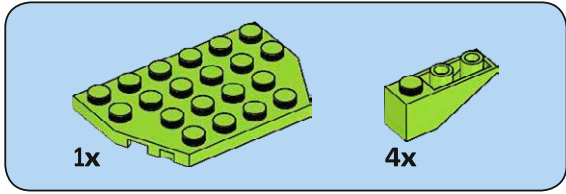

1

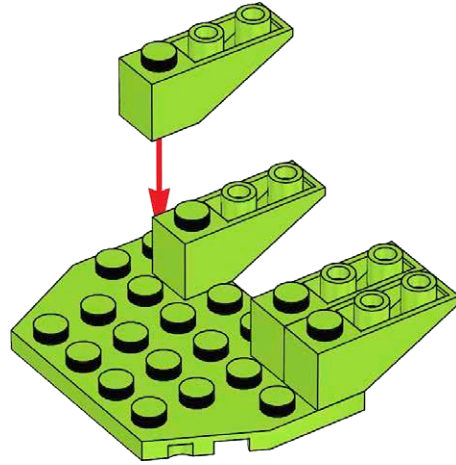

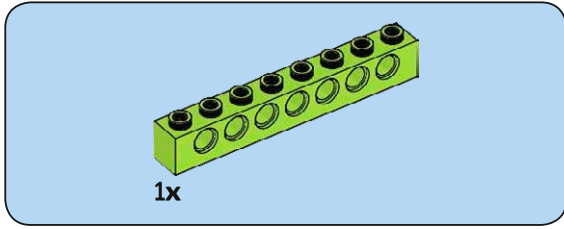

2

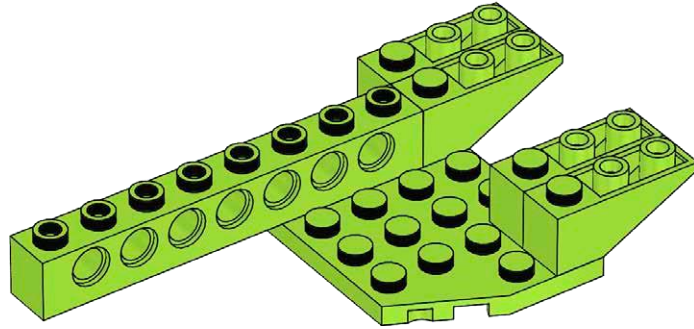

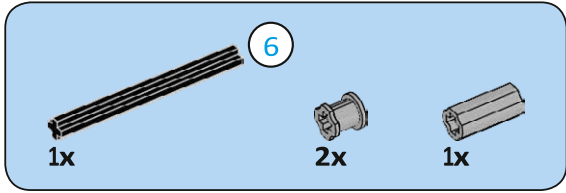

3

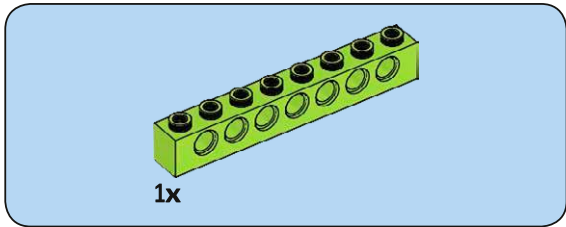
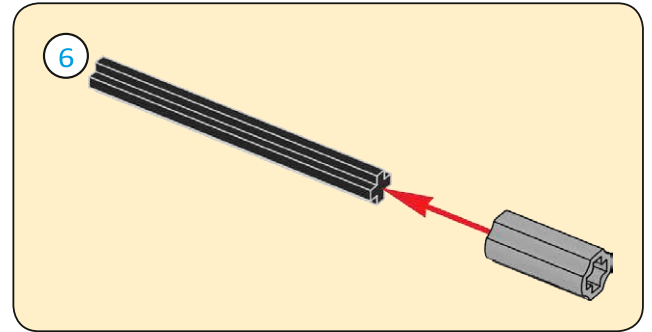
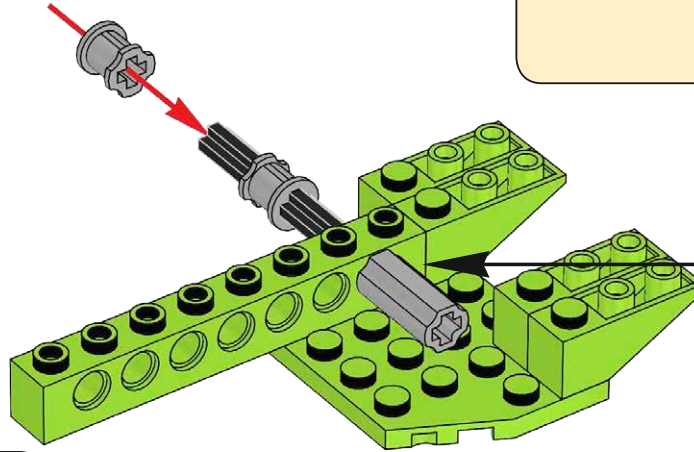

4

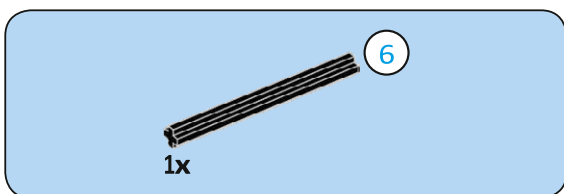
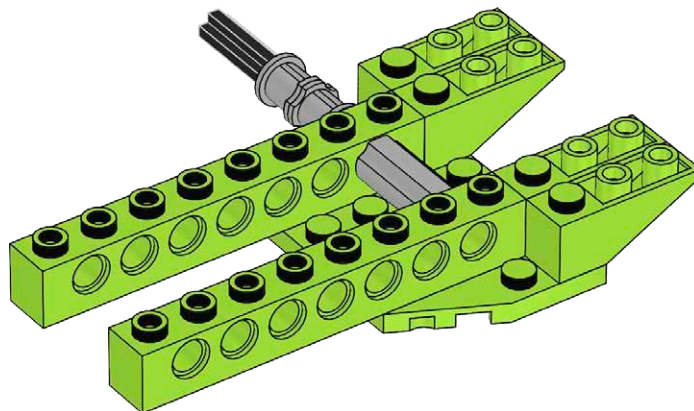

5

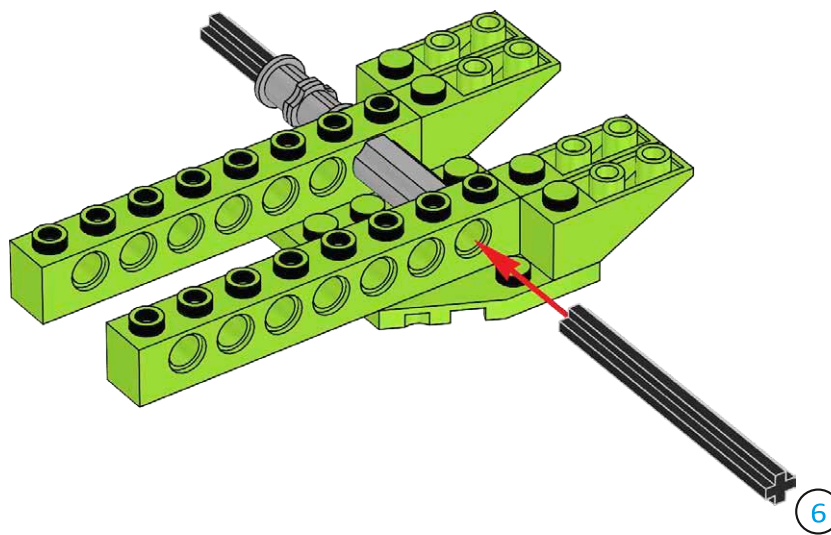

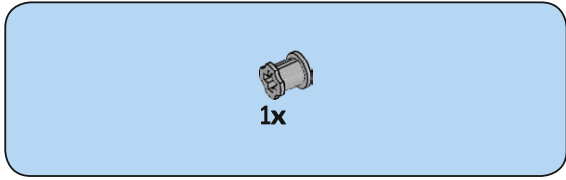

6

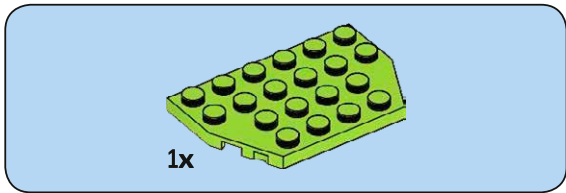
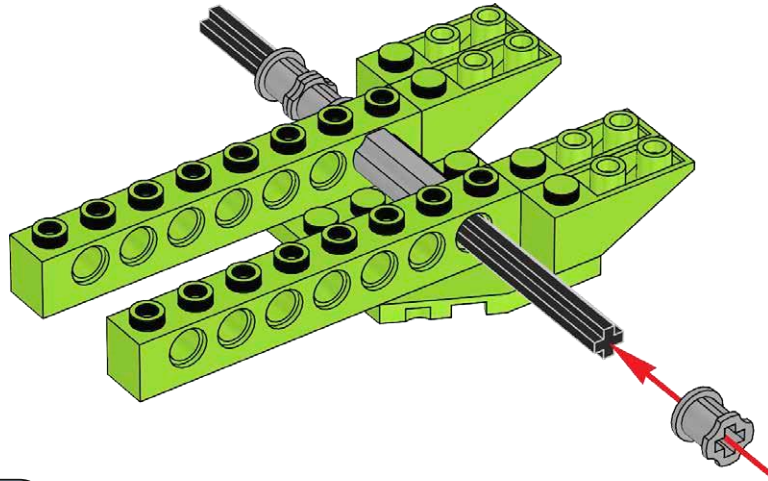

7

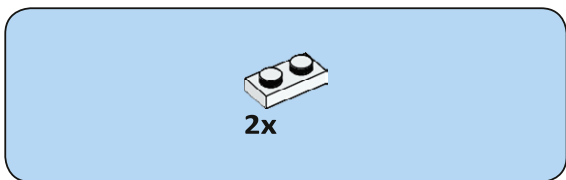
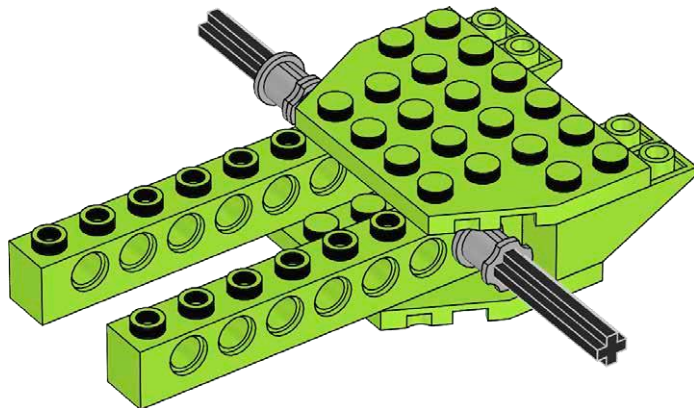

8

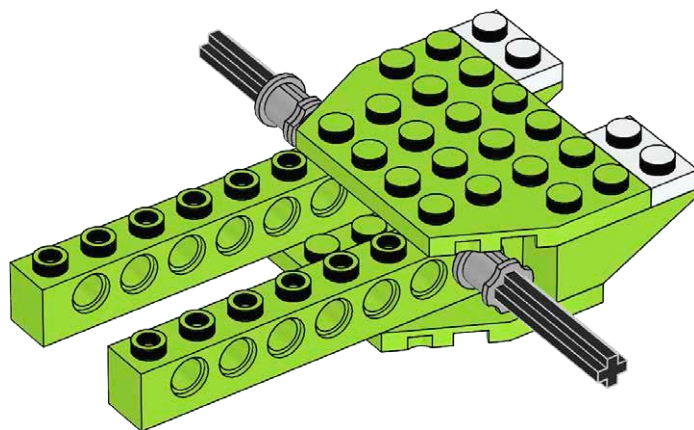

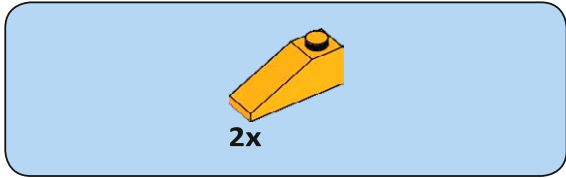

9

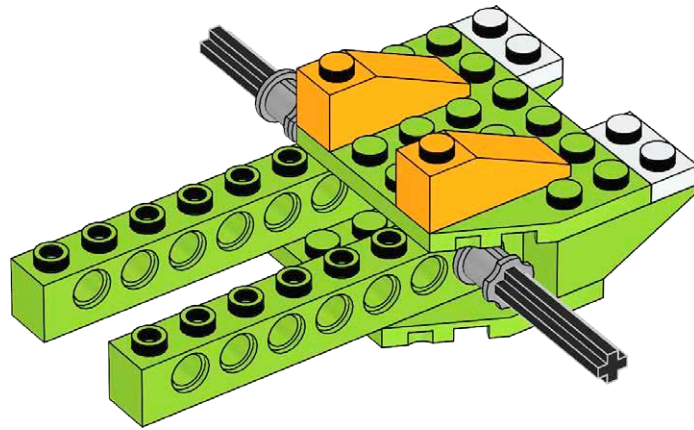

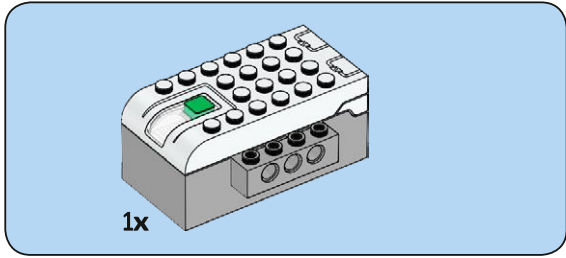

10

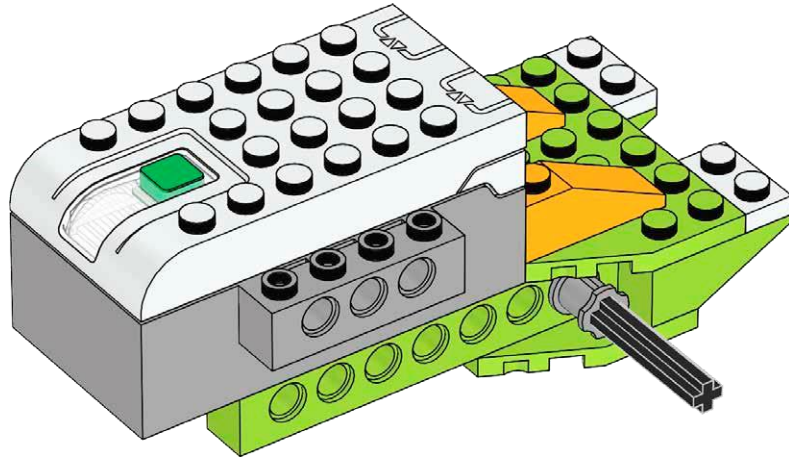

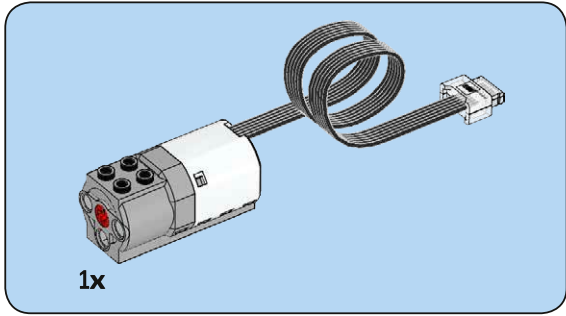

11

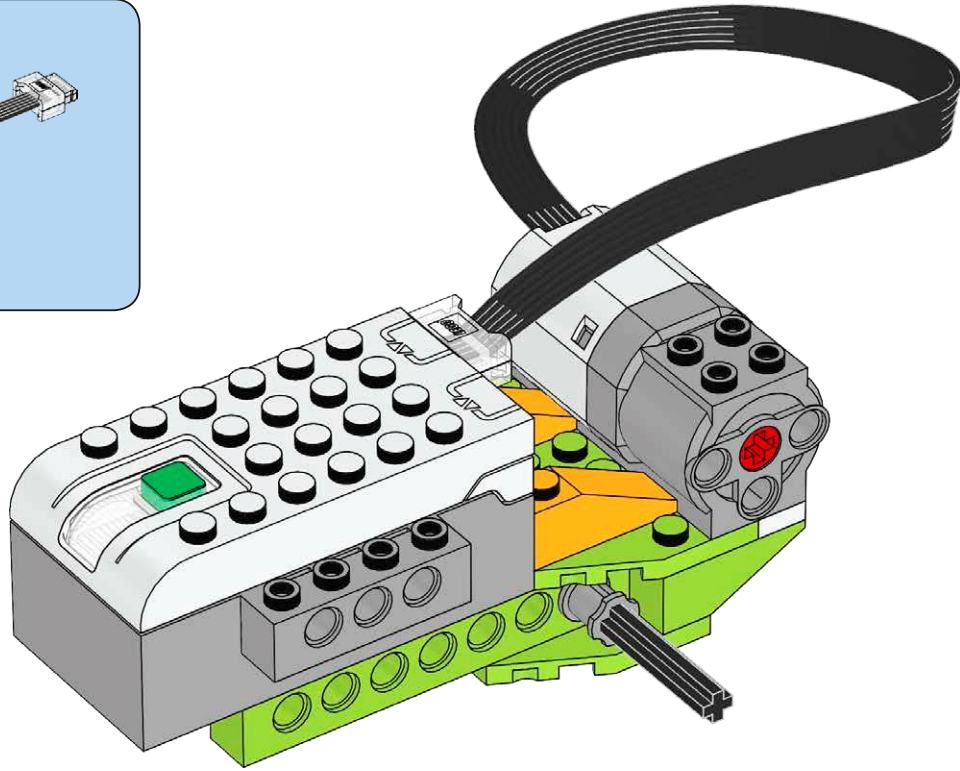

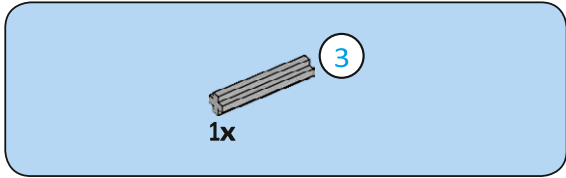

12

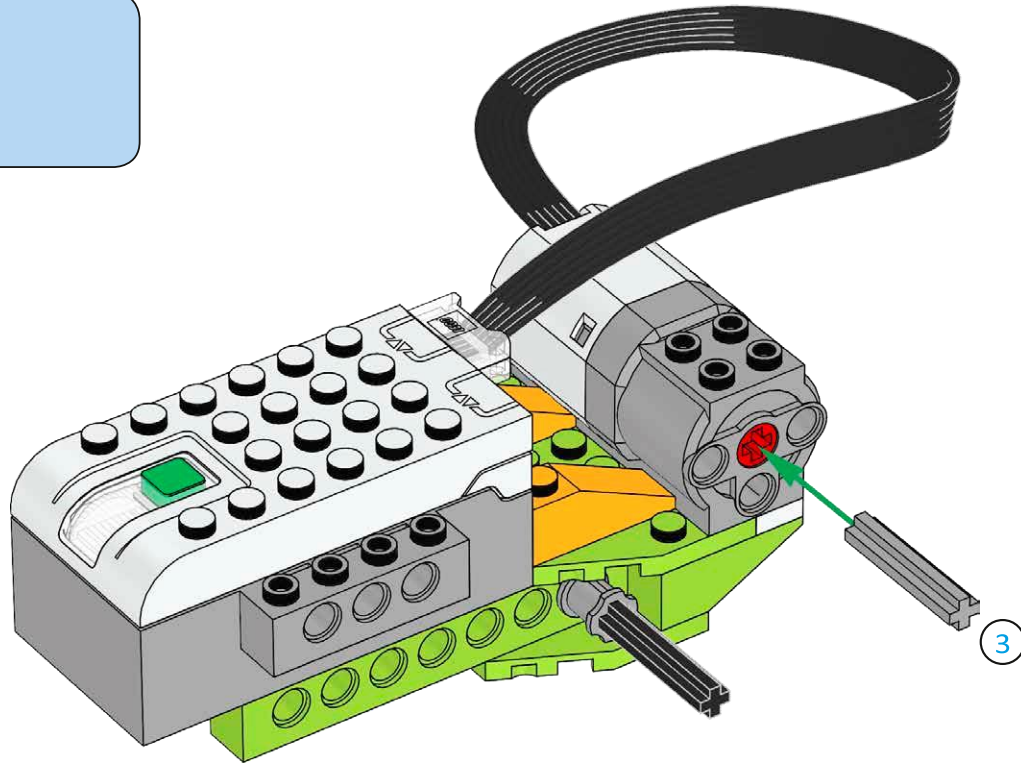

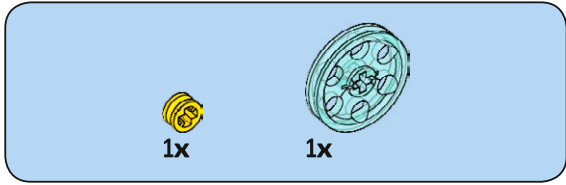

13

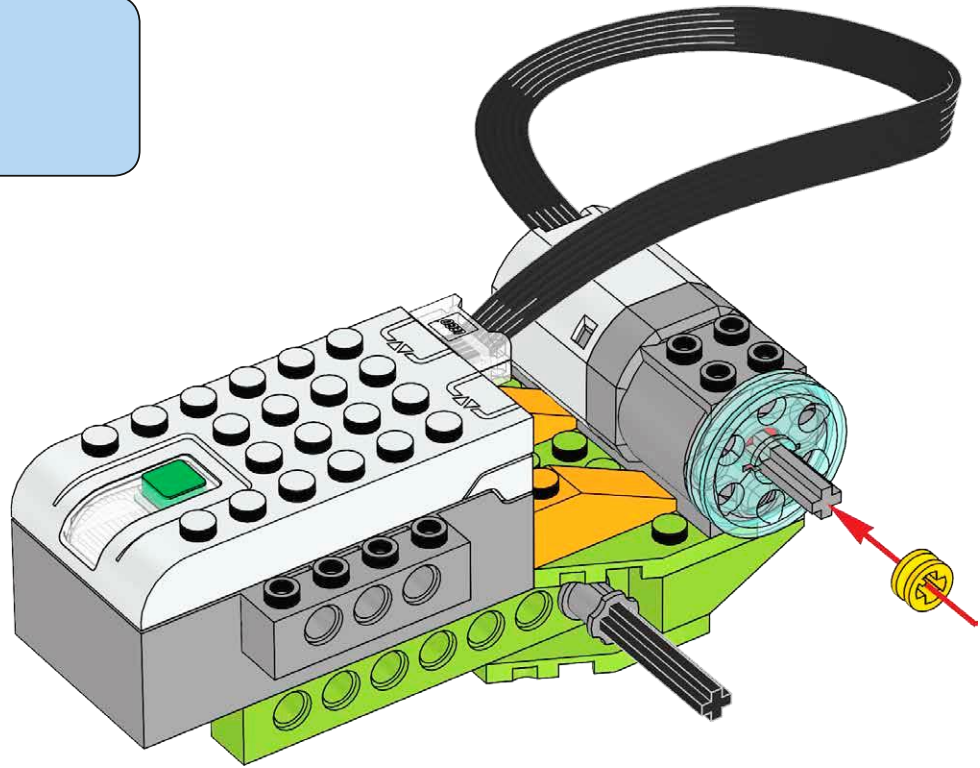

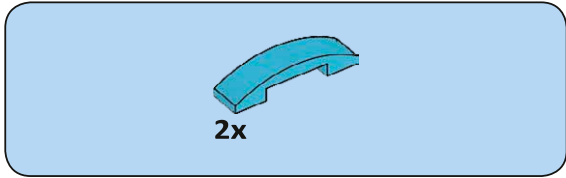

14

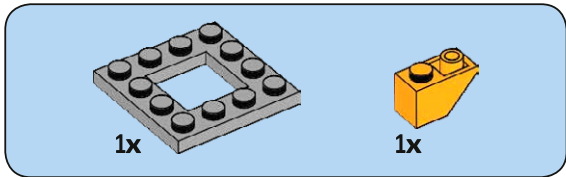
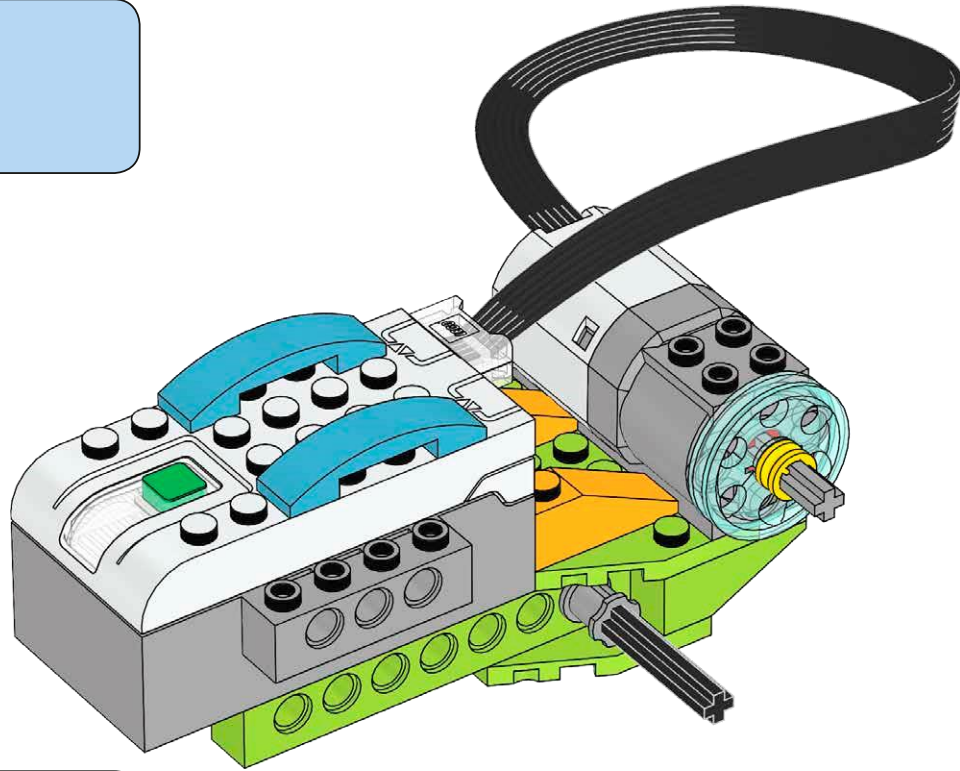

15

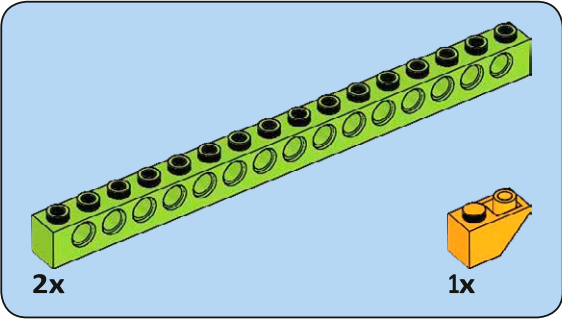
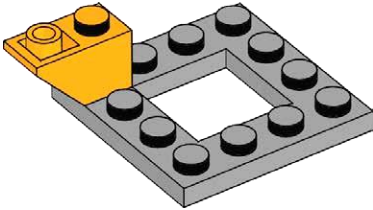

16

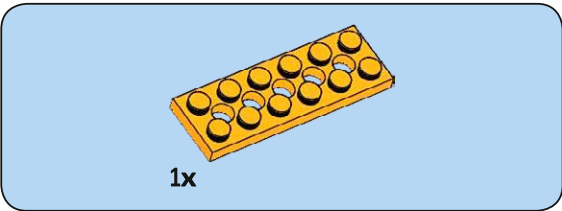
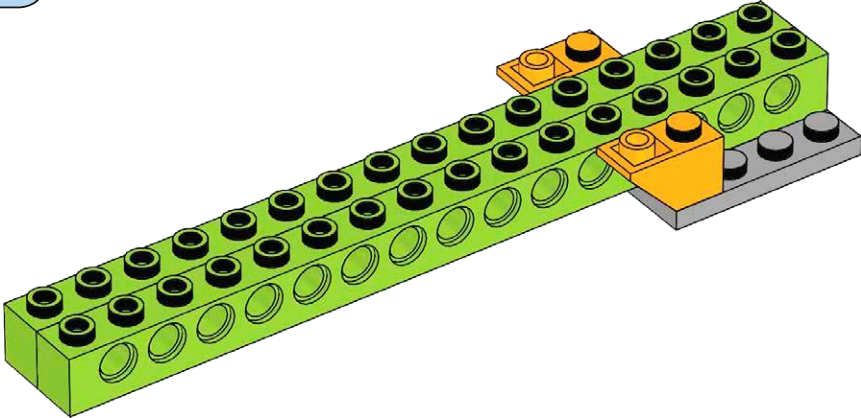

17

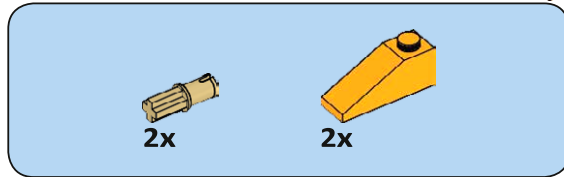
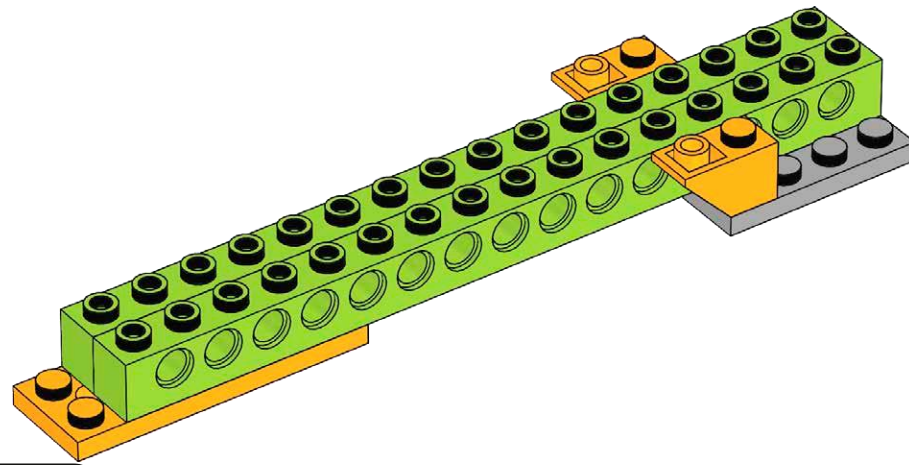

18

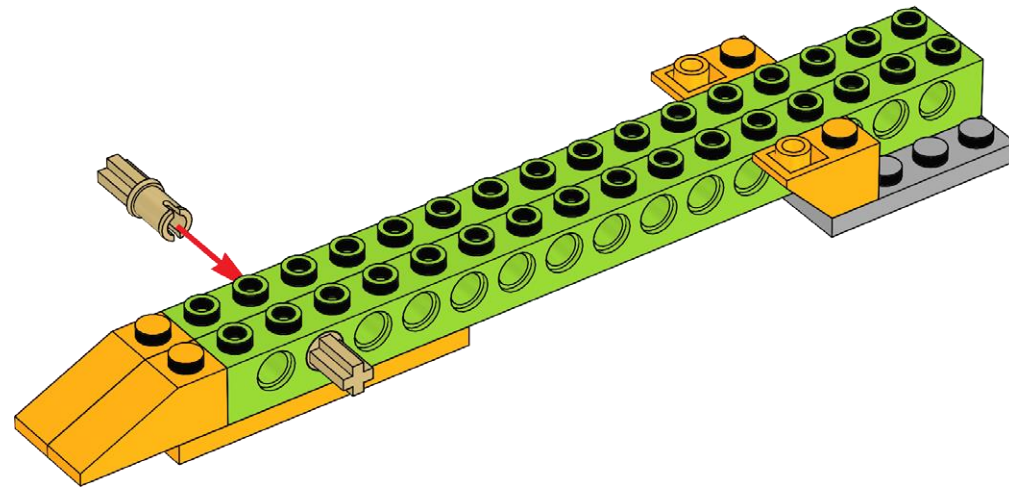

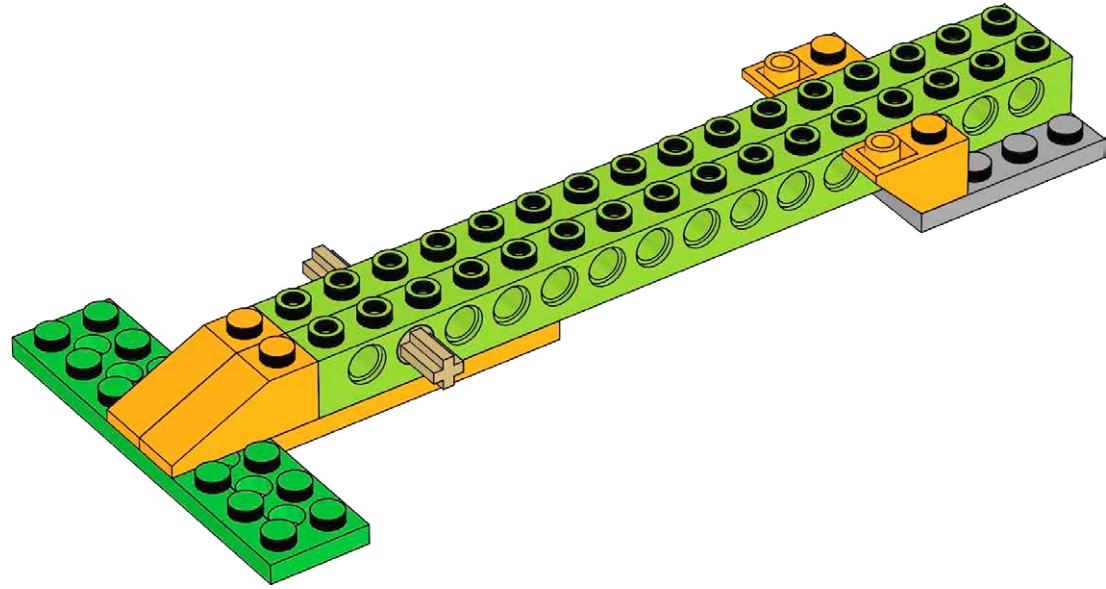
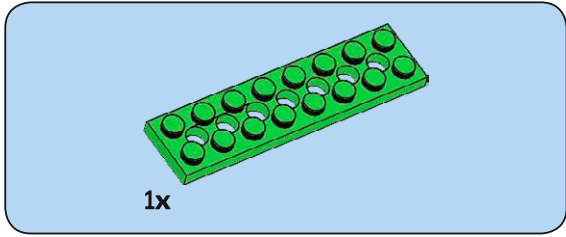

19

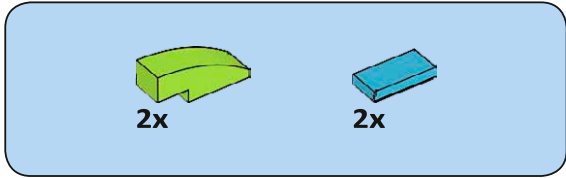

20

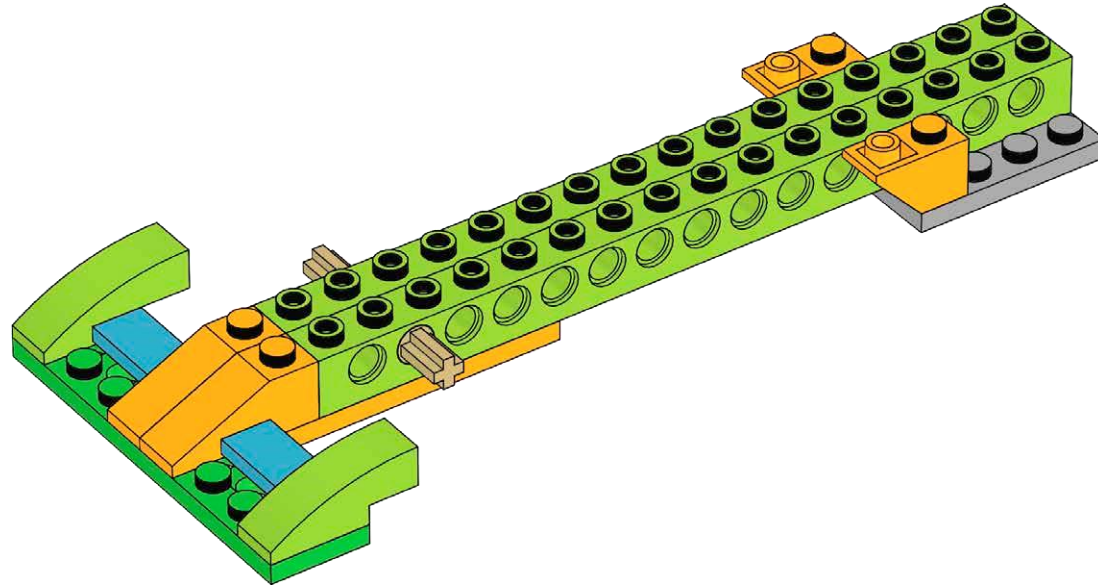

21

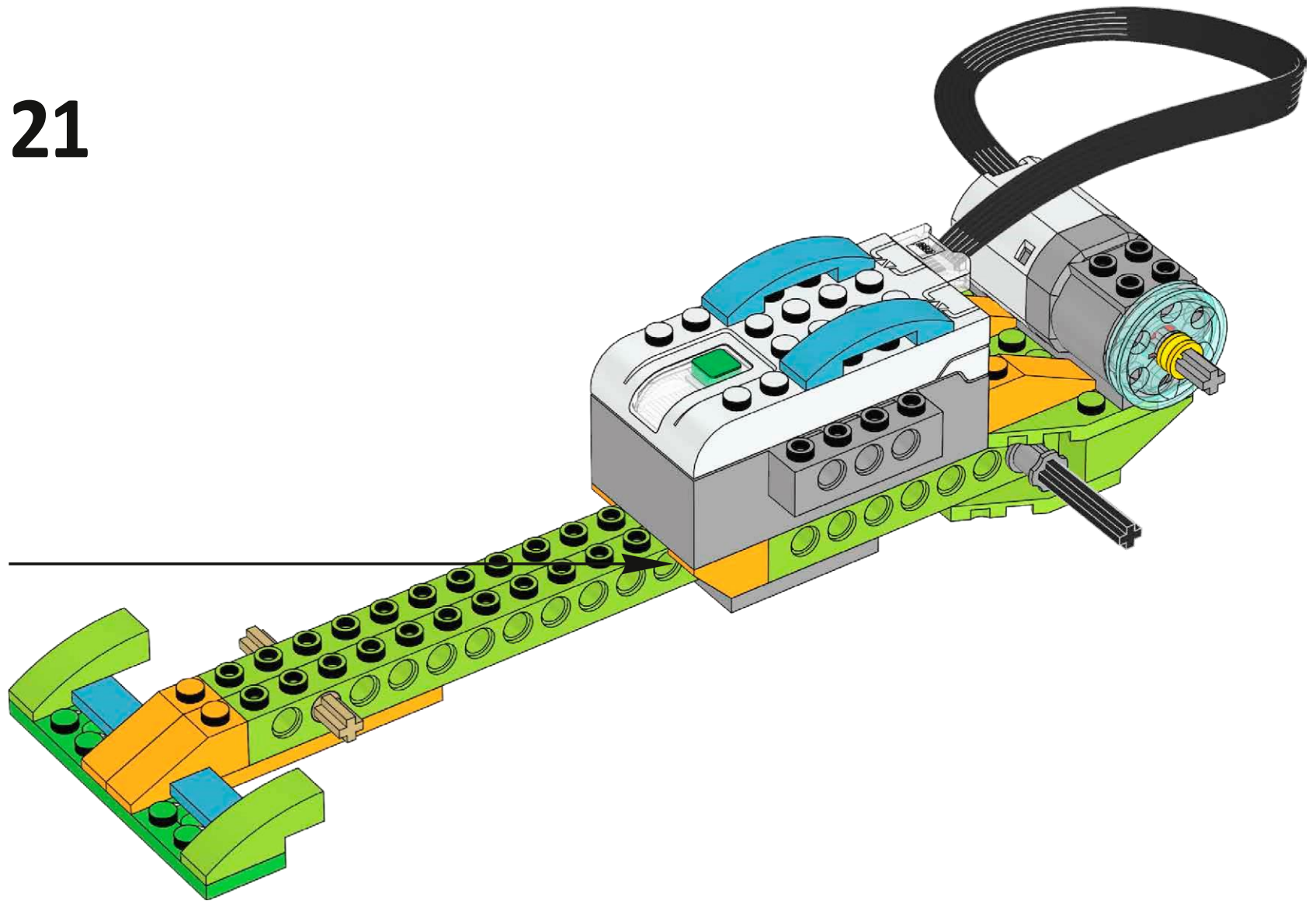

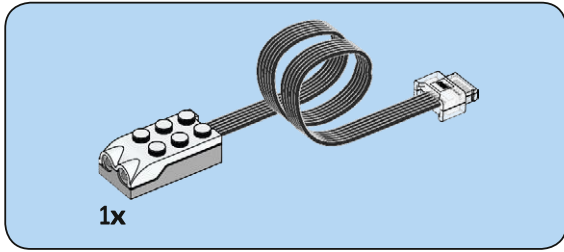

22

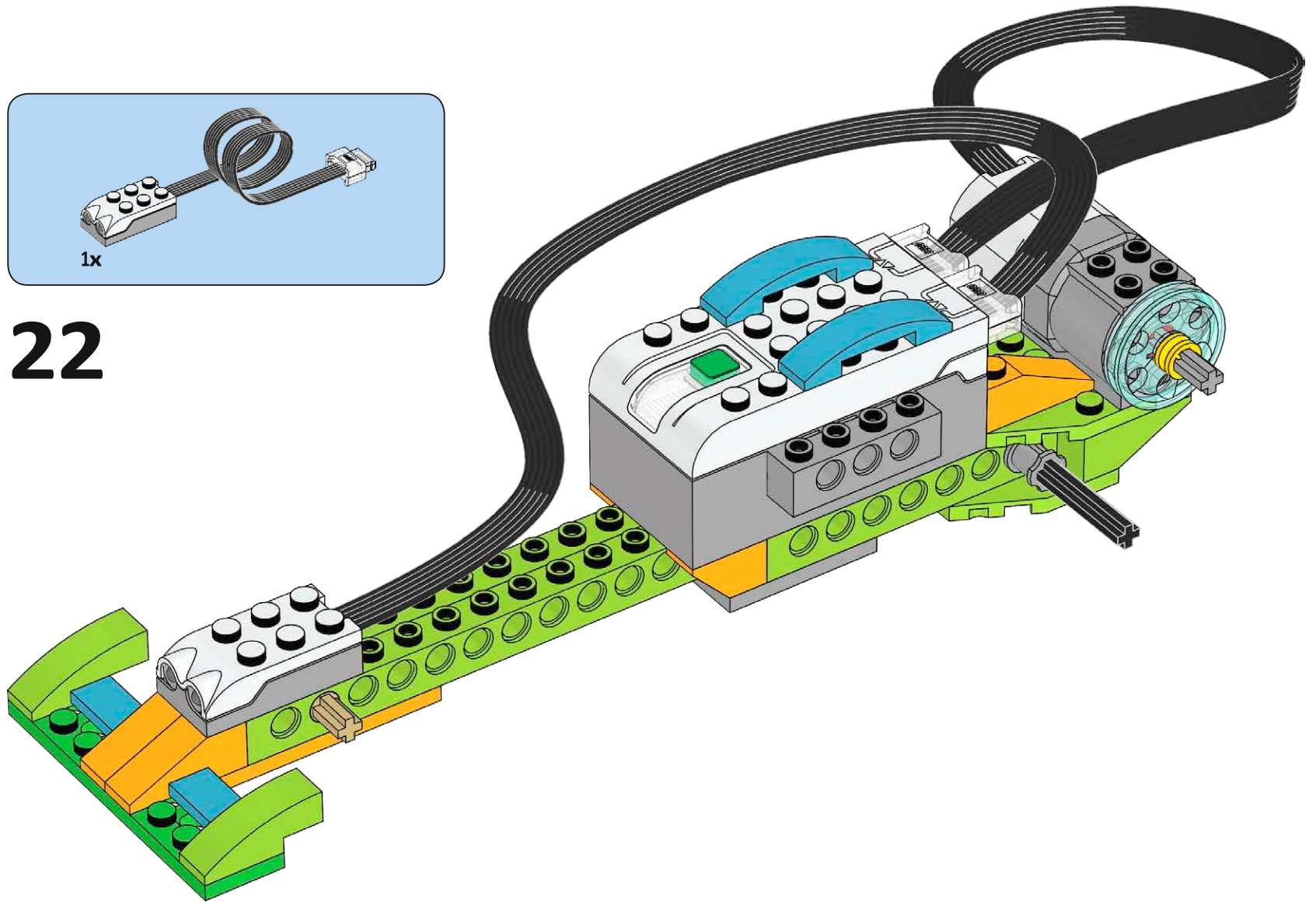

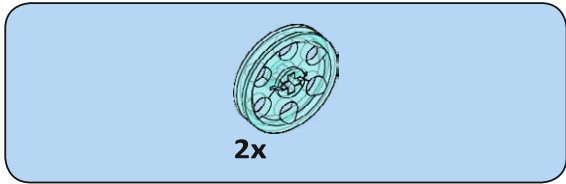

23

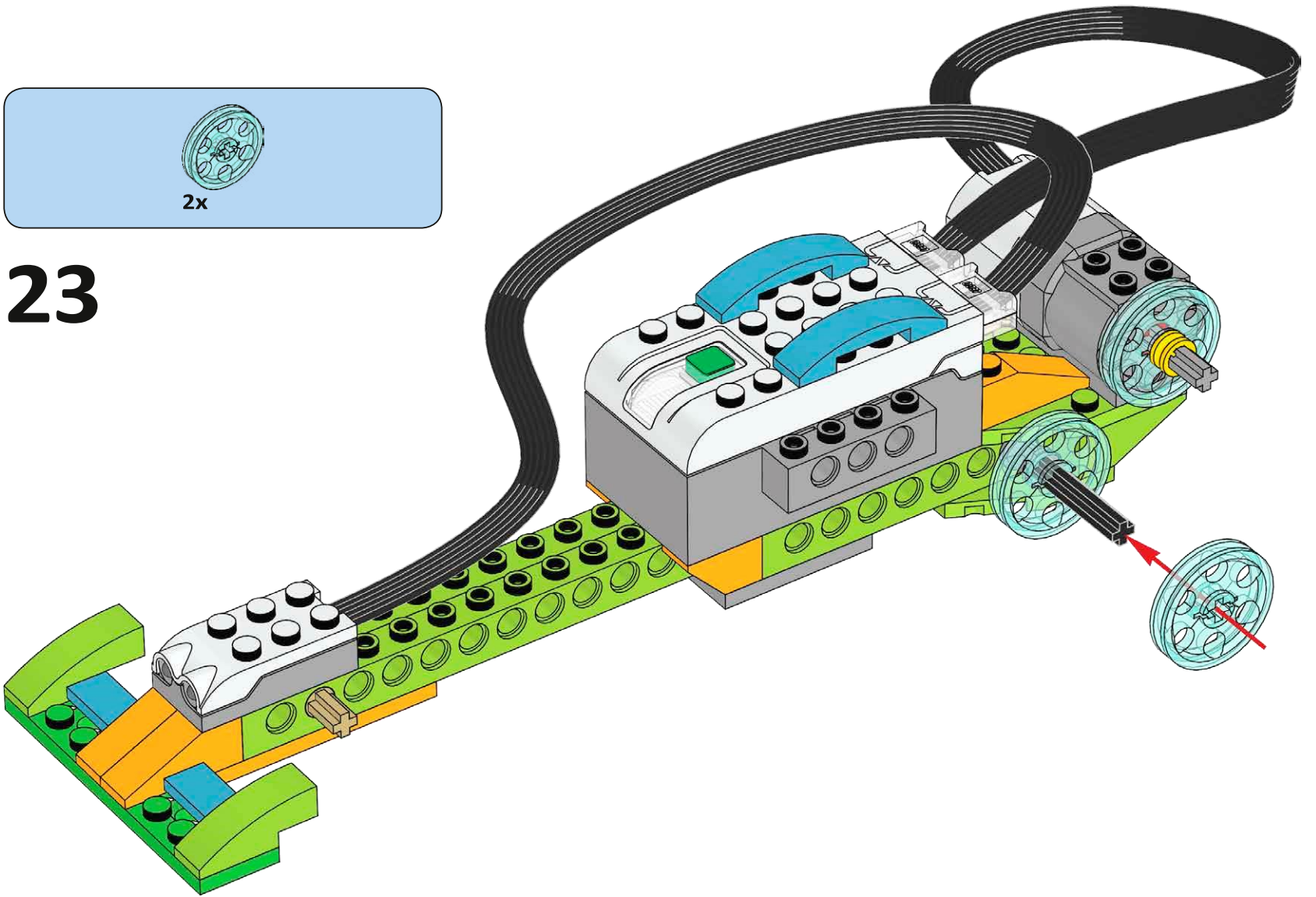

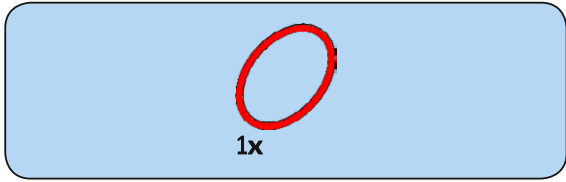

24

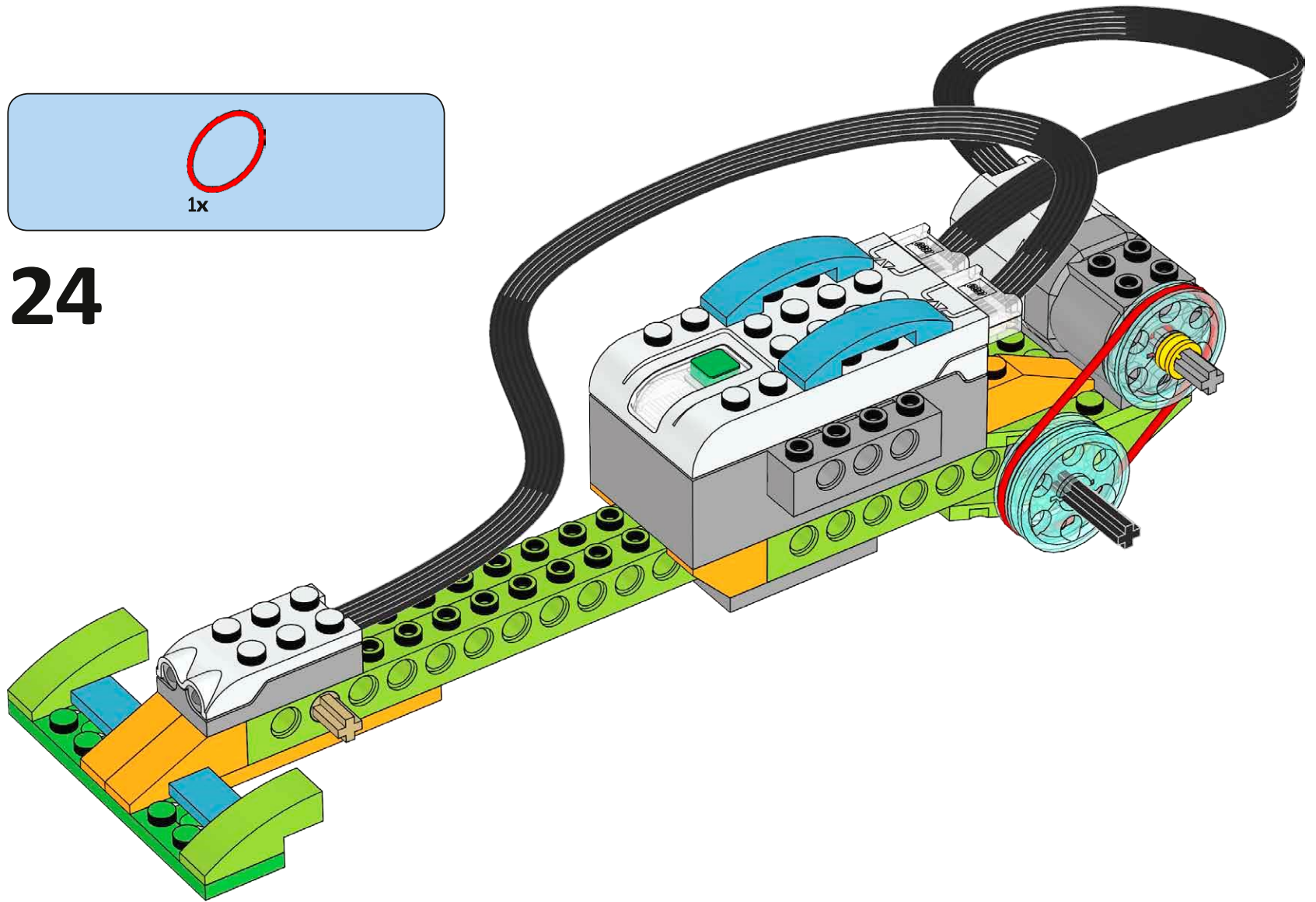

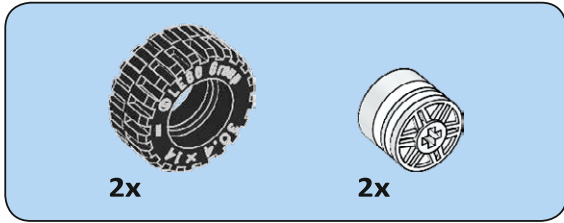

25

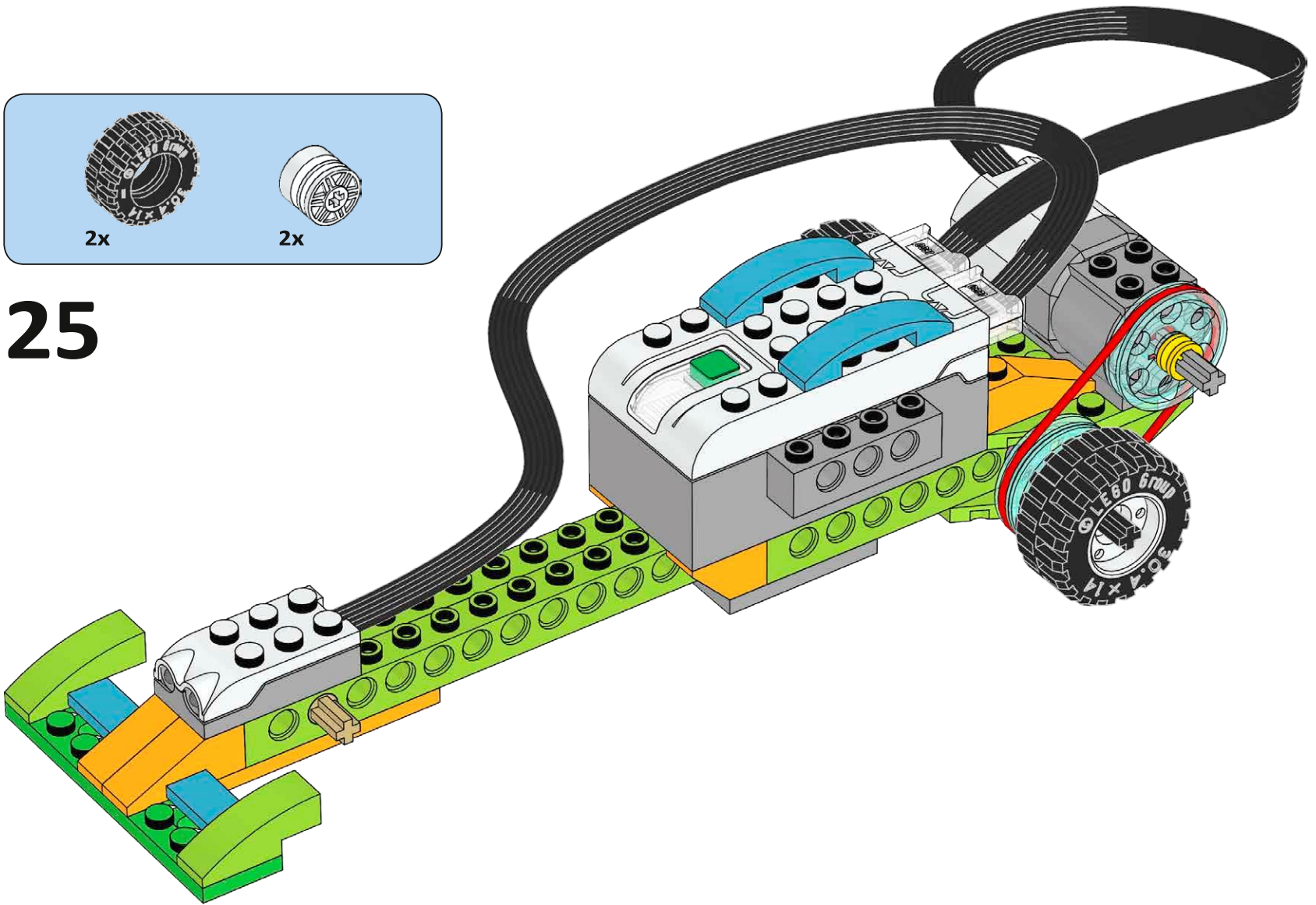

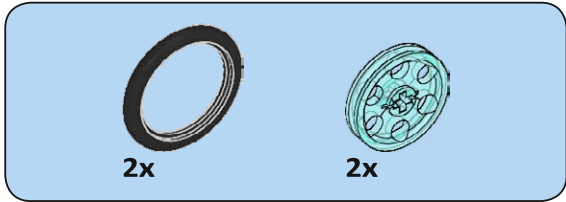

26

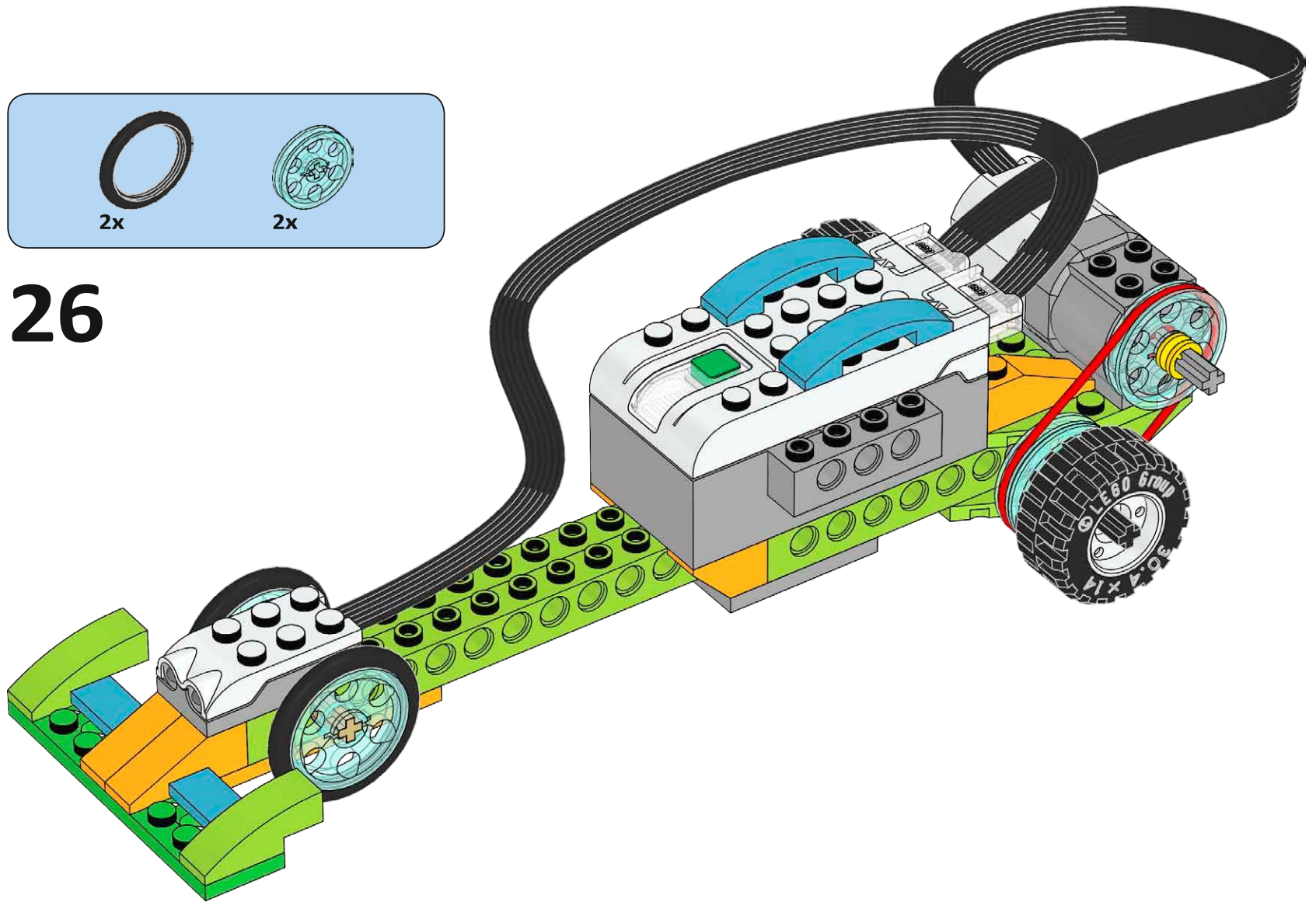

27

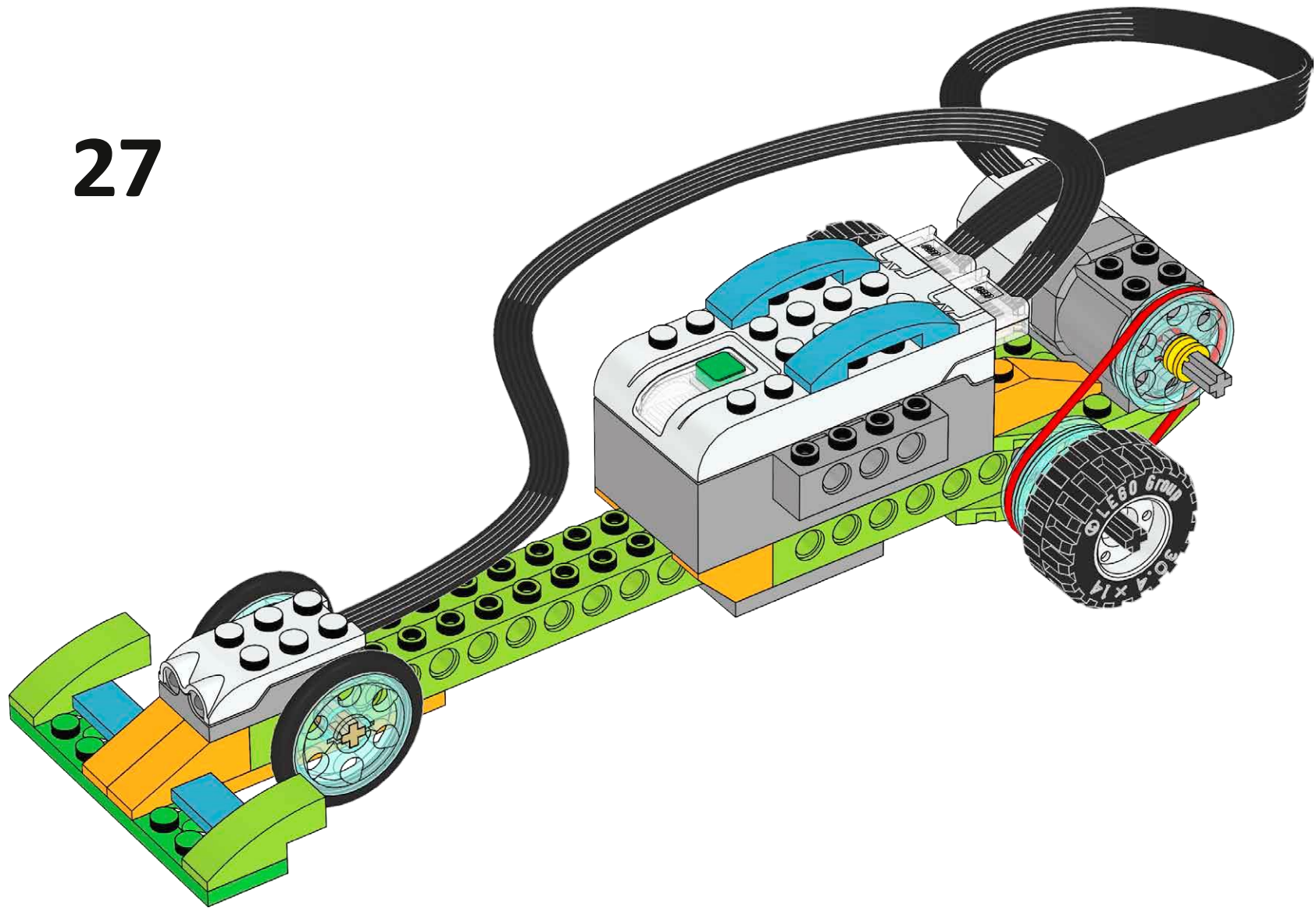

WEDO – versenyautó

Építsünk és programozzunk versenyautót

Ezeket a járműveket úgy tervezték, hogy a lehető leggyorsabban tudjanak menni.

1. Építsük meg a versenyautót. A projektben használt autó ékszíjtárcsákat használ, amelyet két módon lehet összekötni: lassú állásba (kis ékszíjtárcsát összekötve a nagy ékszíjtárcsával) vagy normál állásba (nagy ékszíjtárcsát összekötve a nagy ékszíjtárcsával).
2. Programozzuk a versenyautót az idő kiszámítására. A program indítása előtt a tanulók tegyék a kezüket a versenyautó elé. A program úgy indul, hogy a kijelzőjén egy 0 jelenik meg és várja a rajtjelet. Amikor a tanulók elveszik a kezüket, a program maximális sebességgel elindítja a motort, és addig működteti, amíg egy tárgy (cél) kerül az autó elé. Ekkor a motor leáll és vége van a versenynek
 - a távolságot minimum 2 méterben határozzák meg.
 - minden tanuló jelölje be a kezdővonalat és állítson fel egy akadályt, amely majd megállítja az autót.





FONTOS! A diákoknak muszáj a kezüket az autó előtt tartaniuk, mielőtt elindítják a programot. Amikor elveszik a kezüket az autó azonnal elindul.

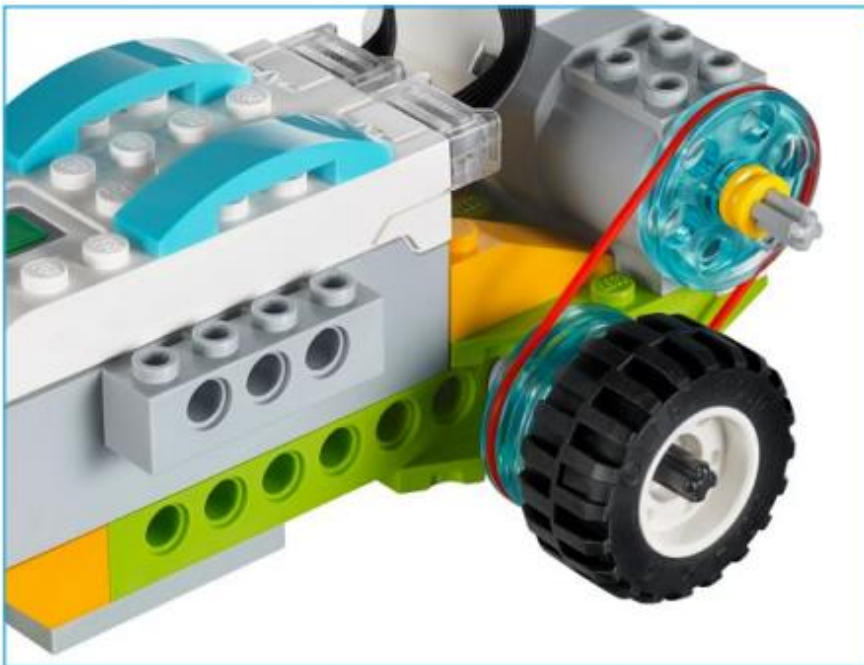

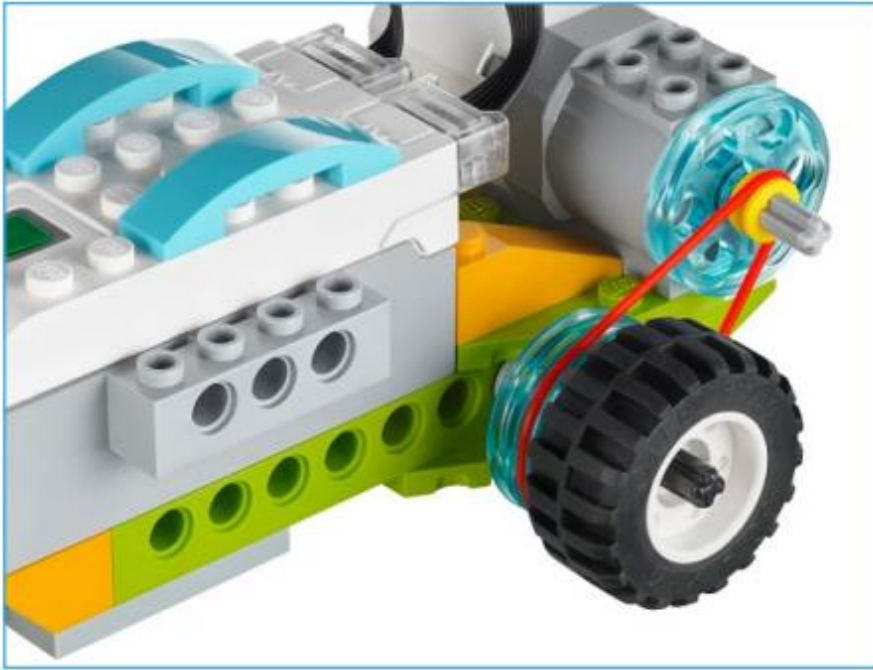

[lego wedo race car - Google-keresés](#)

[10 - WeDo 2.0 - Race Car - step by step instruction \(youtube.com\)](#)